



- 8A Single Device Power
- Up to 90% efficiency (PT6501)
- Small SIP Footprint
- Standby Function
- Internal Short Circuit Protection
- Over-Temperature Protection
- Adjustable Output Voltage

The PT6500 series is a high performance +3.1 to 6V input, 8 Amp, 14-Pin SIP (Single In-line-Package) Inte-

grated Switching Regulator (ISR). This ISR allows the integration of high-speed, low-voltage Pentium processors and their support logic into existing 3.3V or 5V systems without redesigning the central power supply. The PT6502 (1.5V) provides the low terminating voltages required by BTL/Futurebus+, CTT, HP, and GTL Buses from existing 3.3V or 5V power rails.

Standard Application

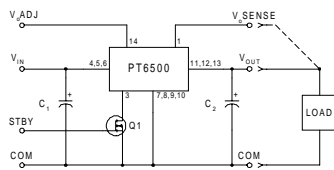

C₁ = Required 330µF electrolytic *
 C₂ = Required 330µF electrolytic *
 * See footnotes

Pin-Out Information

Pin	Function
1	Remote Sense
2	Do not connect
3	STBY*-Standby
4	V _{in}
5	V _{in}
6	V _{in}
7	GND
8	GND
9	GND
10	GND
11	V _{out}
12	V _{out}
13	V _{out}
14	V _{out} Adjust

Ordering Information

PT6501!	= 3.3 Volts
† PT6502!	= 1.5 Volts
PT6503!	= 2.5 Volts
PT6504!	= 3.6 Volts
† PT6505!	= 1.2 Volts
† PT6506!	= 1.8 Volts
† PT6507!	= 1.3 Volts
† PT6508!	= 1.7 Volts

†3.3V Input Bus Capable

PT Series Suffix (PT1234X)

Case/Pin Configuration	Heat Tab Configuration	
	None	Side
Vertical Through-Hole	N	R
Horizontal Through-Hole	A	G
Horizontal Surface Mount	C	B

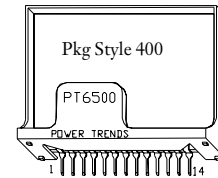

Specifications

Characteristics (T _a =25°C unless noted)	Symbols	Conditions	PT6500 SERIES				
			Min	Typ	Max	Units	
Output Current	I _o	Over V _{in} range	0.1 (1)	—	8.0	A	
Current Limit	I _{cl}	V _{in} =+5V	—	13.0	20.0	A	
Short Circuit Current	I _{sc}	V _{in} =+5V	—	15.0	—	Apk	
Input Voltage Range	V _{in}	0.1 ≤ I _o ≤ 8.0A V _o =2.5V and 3.3V V _o ≤ 1.8V V _o = 3.6V	4.5 3.1 4.8	—	6 6 6	V	
Output Voltage Tolerance	ΔV _o	V _{in} = +5V, I _o = 8.0A T _a = 0 to +70°C	V _o -0.1	—	V _o +0.1	V	
Line Regulation	Reg _{line}	4.5V ≤ V _{in} ≤ 6.0V, I _o = 8.0A 3.1V ≤ V _{in} ≤ 6.0V, I _o = 8.0A 4.5V ≤ V _{in} ≤ 6.0V, I _o = 8.0A	V _o ≥ 3.3V V _o ≤ 1.8V V _o = 2.5V	— — —	±7 ±3 ±7	±17 ±8 ±13	mV
Load Regulation	Reg _{load}	0.1 ≤ I _o ≤ 8.0A, V _{in} = +5V	V _o ≥ 3.3V V _o ≤ 1.8V V _o = 2.5V	— — —	±17 ±12 ±13	±33 ±23 ±25	mV
V _o Ripple/Noise	V _n	V _{in} = +5V, I _o = 8.0 Amp	—	50	—	mVpp	
Transient Response with C _o = 330µF	t _{tr} V _{os}	I _o step from 4A to 8.0A V _o over/undershoot	— —	100 150	— —	µsec mV	
Efficiency	η	V _{in} = +5V, I _o = 3.0A	V _o ≥ 3.3V V _o = 2.5V V _o = 1.8V V _o = 1.5V V _o = 1.2V	— — — — —	90 85 78 76 67	— — — — —	%
		V _{in} = +5V, I _o = 8.0A	V _o ≥ 3.3V V _o = 2.5V V _o = 1.8V V _o = 1.5V V _o = 1.2V	— — — — —	83 76 74 68 65	— — — — —	%
Switching Frequency	f _o	Over V _{in} and I _o ranges	475	600	725	kHz	
Absolute Maximum Operating Temperature Range	T _a		-40 (3)	—	+85 (4)	°C	
Thermal Resistance	θ _{ja}	Free Air Convection (40-60LFM)	—	15	—	°C/W	

Continued

PT6500 Series

8 Amp 5V/3.3V Input Adjustable ISR with Short-Circuit Protection

Specifications (continued)

Characteristics ($T_a=25^\circ\text{C}$ unless noted)	Symbols	Conditions	PT6500 SERIES			Units
			Min	Typ	Max	
Storage Temperature	T_s	—	-40	—	+125	$^\circ\text{C}$
Mechanical Shock		Per Mil-STD-883D, Method 2002.3, 1msec, half sine, fixture mounted	—	500	—	G's
Mechanical Vibration		Per Mil-STD-883D, Methode 2007.2, 20-20,000 Hz, soldered in a PC board	—	7.5	—	G's
Weight			—	23	—	grams

- Notes: (1) ISR will operate down to no load with reduced specifications.
 (2) The minimum input voltage required by the part is $V_{out} + 1.2V$ or $3.1V$, whichever is greater.
 (3) For operation below 0°C , use tantalum capacitors. For more information see the related applicoin note, "PT6000/7000 Series Capacitor Recommendations."
 (4) See Thermal Derating charts.

Input/Output Capacitors: The PT6500 series requires a $330\mu\text{F}$ electrolytic or tantalum input and output capacitor for proper operation in all applications. C_1 (input) must be rated for $1.2A_{rms}$ and $100m\Omega$ max. ESR. C_2 (output) must be rated for $400mArms$ ripple current and 0.2Ω max. ESR.

TYPICAL CHARACTERISTICS

PT6501, 3.3 VDC, $V_{in}=5.0V$

(See Note A)

Efficiency vs Output Current

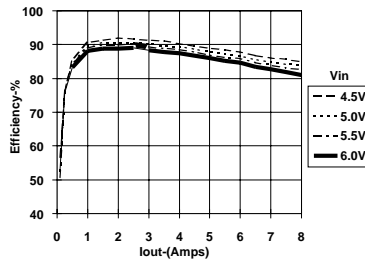

Ripple vs Output Current

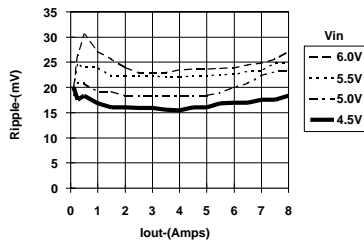

Power Dissipation vs Output Current

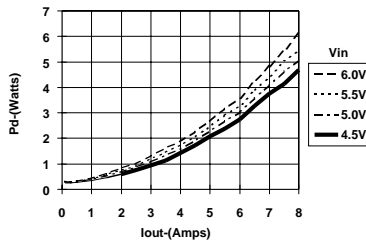

PT6502, 1.5 VDC, $V_{in}=5.0V$

(See Note A)

Efficiency vs Output Current

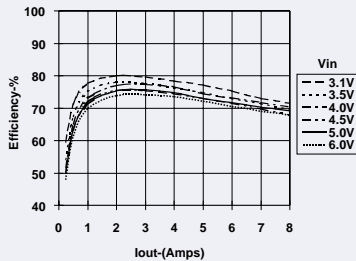

Ripple vs Output Current

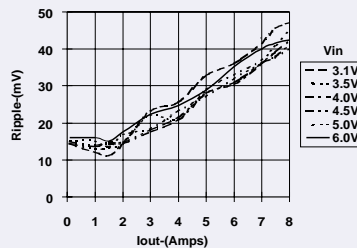

Power Dissipation vs Output Current

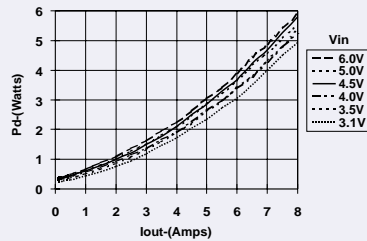

PT6503, 2.5 VDC, $V_{in}=5.0V$

(See Note A)

Efficiency vs Output Current

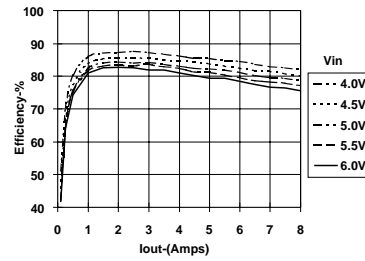

Ripple vs Output Current

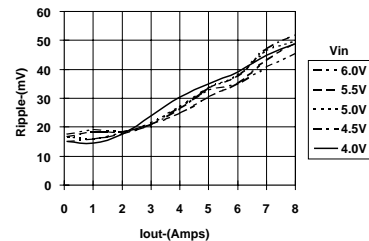

Power Dissipation vs Output Current

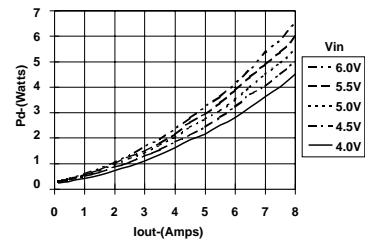

Note A: All data listed in the above graphs has been developed from actual products tested at 25°C . This data is considered typical data for the ISR.

Thermal Derating Curves

Air Flow (LFM)

60

200

300

PT6501

No Heat Tab

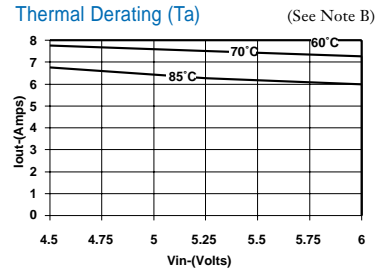
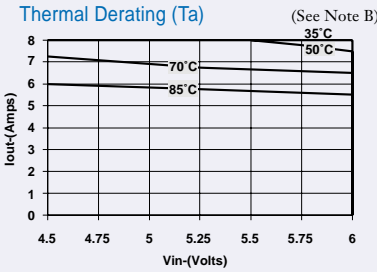
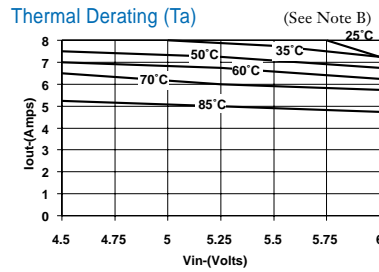

Heat Tab

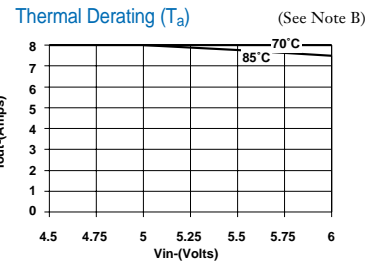
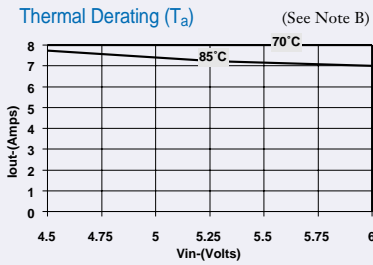
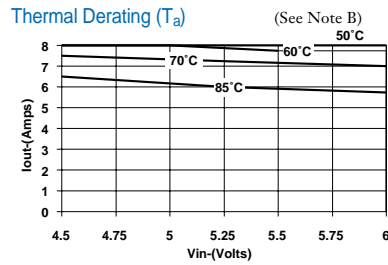

PT6502

No Heat Tab

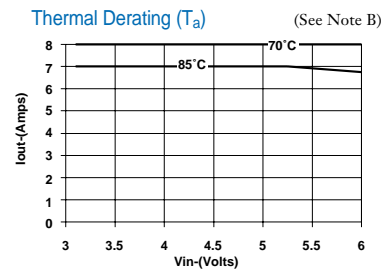
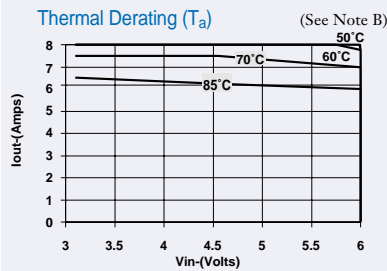
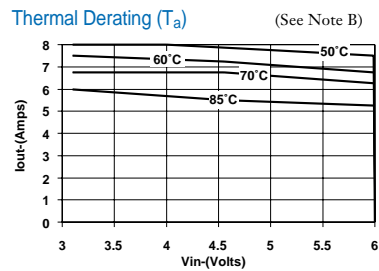

Heat Tab

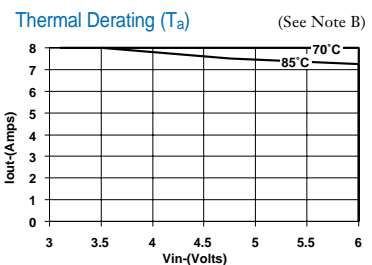
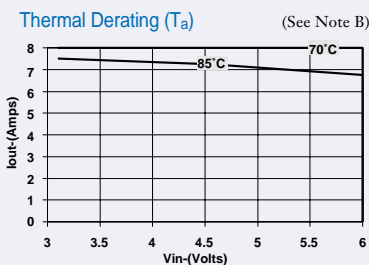
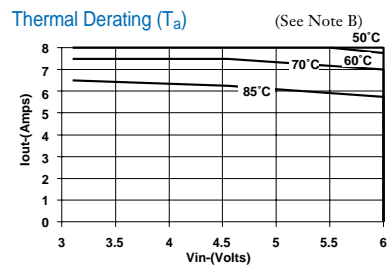

Note B: Thermal derating graphs are developed in different air flow rates as indicated on each graph, with or without the heat tab, soldered in a printed circuit board.

THERMAL DERATING CURVES

Air Flow (LFM)
60

200

300

PT6503

No Heat Tab

Thermal Derating (Ta) (See Note B)

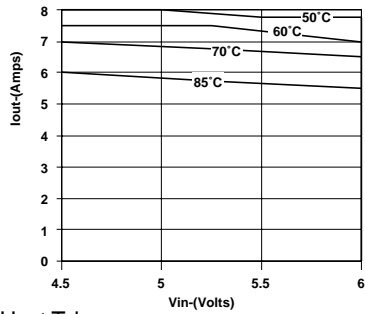

Thermal Derating (Ta) (See Note B)

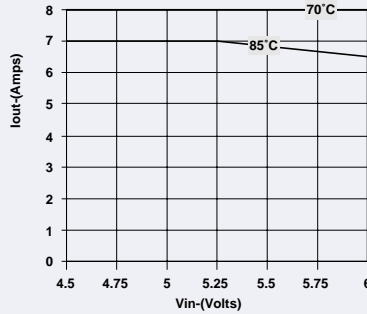

Thermal Derating (Ta) (See Note B)

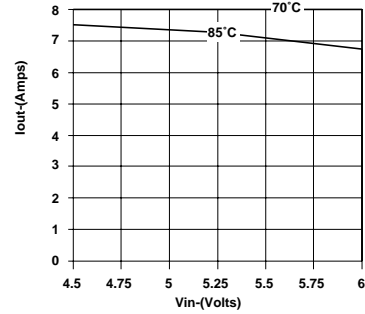

Heat Tab

Thermal Derating (Ta) (See Note B)

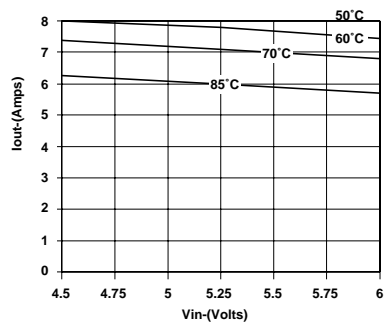

Thermal Derating (Ta) (See Note B)

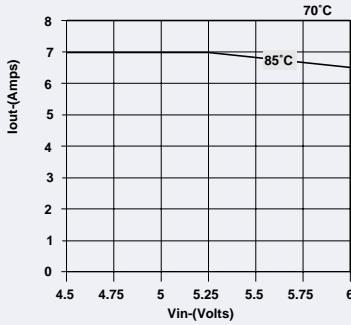

Thermal Derating (Ta) (See Note B)

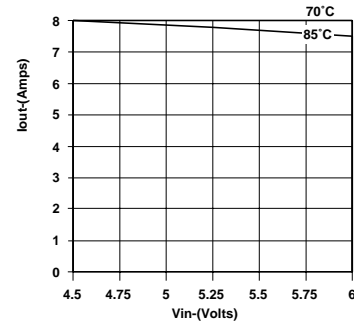

Note B: Thermal derating graphs are developed in different air flow rates as indicated on each graph, with or without the heat tab, soldered in a printed circuit board.

PT6500 Series

Adjusting the Output Voltage of the PT6500 5V/3.3V Bus Converters

The output voltage of the Power Trends PT6500 Series ISRs may be adjusted higher or lower than the factory trimmed pre-set voltage with the addition of a single external resistor. Table 1 accordingly gives the allowable adjustment range for each model in the series as V_a (min) and V_a (max).

Adjust Up: An increase in the output voltage is obtained by adding a resistor R2, between pin 14 (V_o adjust) and pins 7-10 (GND).

Adjust Down: Add a resistor (R1), between pin 14 (V_o adjust) and pins 11-13 (V_{out}).

Refer to Figure 1 and Table 2 for both the placement and value of the required resistor, either (R1) or R2 as appropriate.

Notes:

1. Use only a single 1% resistor in either the (R1) or R2 location. Place the resistor as close to the ISR as possible.
2. Never connect capacitors from V_o adjust to either GND, V_{out} , or the Remote Sense pin. Any capacitance added to the V_o adjust pin will affect the stability of the ISR.
3. If the Remote Sense feature is being used, connecting the resistor (R1) between pin 14 (V_o adjust) and pin 1 (Remote Sense) can benefit load regulation.
4. The minimum input voltage required by the part is $V_{out} + 1.2$ or $V_{in(min)}$ from Table 1, whichever is higher.

Figure 1

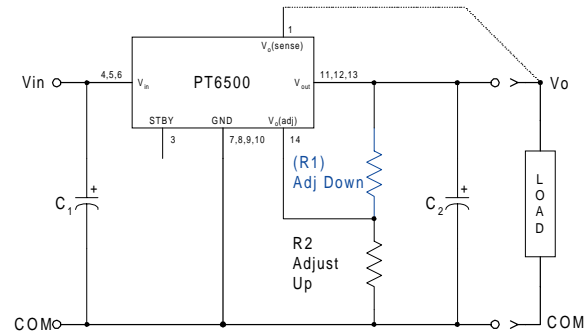

The values of (R1) [adjust down], and R2 [adjust up], can also be calculated using the following formulae.

$$(R1) = \frac{R_o (V_a - 1.0)}{(V_o - V_a)} - R_s \text{ k}\Omega$$

$$R2 = \frac{R_o}{V_a - V_o} - R_s \text{ k}\Omega$$

Where: V_o = Original output voltage
 V_a = Adjusted output voltage
 R_o = The resistance value in Table 1
 R_s = The series resistance from Table 1

Table 1

PT6500 ADJUSTMENT AND FORMULA PARAMETERS

Series Pt #	PT6505	PT6507	PT6502	PT6508	PT6506	PT6503	PT6501	PT6504
V_o (nom)	1.2	1.3	1.5	1.7	1.8	2.5	3.3	3.6
V_a (min)	1.14	1.19	1.27	1.36	1.4	1.8	2.25	2.5
V_a (max)	2.35	2.45	2.65	2.85	2.95	3.5	4.2	4.3
R_o (k Ω)	2.49	2.49	2.49	2.49	2.49	4.99	12.1	10.0
R_s (k Ω)	2.0	2.0	2.0	2.0	2.0	4.22	12.1	12.1
$V_{in(min)}$	3.1	3.1	3.1	3.1	3.1	4.5	4.5	4.5

PT6500 Series

Table 2

PT6500 ADJUSTMENT RESISTOR VALUES									
Series Pt #	PT6505	PT6507	PT6502	PT6508	PT6506	PT6503	PT6501	PT6504	
V _o (nom)	1.2	1.3	1.5	1.7	1.8	2.5	3.3	3.6	
V _a (req'd)									
1.15	(5.5)kΩ								
1.2		(3.0)kΩ							
1.25	47.8kΩ	(10.5)kΩ							
1.3	22.9kΩ		(1.7)kΩ						
1.35	14.6kΩ	47.8kΩ	(3.8)kΩ						
1.4	10.5kΩ	22.9kΩ	(8.0)kΩ	(1.3)kΩ	(0.5)kΩ				
1.45	8.0kΩ	14.6kΩ	(20.4)kΩ	(2.5)kΩ	(1.2)kΩ				
1.5	6.3kΩ	10.5kΩ		(4.2)kΩ	(2.2)kΩ				
1.55	5.1kΩ	8.0kΩ	47.8kΩ	(7.1)kΩ	(3.5)kΩ				
1.6	4.2kΩ	6.3kΩ	22.9kΩ	(12.9)kΩ	(5.5)kΩ				
1.65	3.5kΩ	4.1kΩ	14.6kΩ	(30.4)kΩ	(8.8)kΩ				
1.7	3.0kΩ	4.2kΩ	10.5kΩ		(15.4)kΩ				
1.75	2.5kΩ	3.5kΩ	8.0kΩ	47.8kΩ	(35.4)kΩ				
1.8	2.2kΩ	3.0kΩ	6.3kΩ	22.9kΩ		(1.5)kΩ			
1.85	1.8kΩ	2.5kΩ	5.1kΩ	14.6kΩ	47.8kΩ	(2.3)kΩ			
1.9	1.6kΩ	2.2kΩ	4.2kΩ	10.5kΩ	22.9kΩ	(3.3)kΩ			
1.95	1.3kΩ	1.8kΩ	3.5kΩ	8.0kΩ	14.6kΩ	(4.4)kΩ			
2.0	1.1kΩ	1.6kΩ	3.0kΩ	6.3kΩ	10.5kΩ	(5.8)kΩ			
2.05	0.9kΩ	1.3kΩ	2.5kΩ	5.1kΩ	8.0kΩ	(7.4)kΩ			
2.1	0.8kΩ	1.1kΩ	2.2kΩ	4.2kΩ	6.3kΩ	(9.5)kΩ			
2.15	0.6kΩ	0.9kΩ	1.8kΩ	3.5kΩ	5.1kΩ	(12.2)kΩ			
2.2	0.5kΩ	0.8kΩ	1.6kΩ	3.0kΩ	4.2kΩ	(15.7)kΩ			
2.25	0.4kΩ	0.6kΩ	1.3kΩ	2.5kΩ	3.5kΩ	(20.7)kΩ	(2.3)kΩ		
2.3	0.3kΩ	0.5kΩ	1.1kΩ	2.2kΩ	3.0kΩ	(28.2)kΩ	(3.6)kΩ		
2.35	0.2kΩ	0.4kΩ	0.9kΩ	1.8kΩ	2.5kΩ	(40.7)kΩ	(5.1)kΩ		
2.4		0.3kΩ	0.8kΩ	1.6kΩ	2.2kΩ	(65.6)kΩ	(6.7)kΩ		
2.45		0.2kΩ	0.6kΩ	1.3kΩ	1.8kΩ	(140.0)kΩ	(8.5)kΩ		
2.5			0.5kΩ	1.1kΩ	1.6kΩ		(10.6)kΩ	(1.5)kΩ	
2.55			0.4kΩ	0.9kΩ	1.3kΩ	95.6kΩ	(12.9)kΩ	(2.7)kΩ	
2.6			0.3kΩ	0.8kΩ	1.1kΩ	45.7kΩ	(15.6)kΩ	(3.9)kΩ	
2.65			0.2kΩ	0.6kΩ	6.9kΩ	29.0kΩ	(18.6)kΩ	(5.3)kΩ	
2.7				0.5kΩ	0.8kΩ	20.7kΩ	(22.2)kΩ	(6.8)kΩ	
2.75				0.4kΩ	0.6kΩ	15.7kΩ	(26.4)kΩ	(8.5)kΩ	
2.8				0.3kΩ	0.5kΩ	12.4kΩ	(31.5)kΩ	(10.4)kΩ	
2.85				0.2kΩ	0.4kΩ	10.0kΩ	(37.6)kΩ	(12.6)kΩ	
2.9					0.3kΩ	8.3kΩ	(45.4)kΩ	(15.0)kΩ	
2.95					0.2kΩ	0.9kΩ	(55.3)kΩ	(17.9)kΩ	
3.0						5.8kΩ	(68.6)kΩ	(21.2)kΩ	
3.1						4.1kΩ	(115.0)kΩ	(29.9)kΩ	
3.2						2.9kΩ	(254.0)kΩ	(42.9)kΩ	
3.3						2.0kΩ		(64.6)kΩ	
3.4						1.3kΩ	109.0kΩ	(108.0)kΩ	
3.5						0.8kΩ	48.4kΩ	(238.0)kΩ	
3.6							28.2kΩ		
3.7							18.2kΩ	87.9kΩ	
3.8							12.1kΩ	37.9kΩ	
3.9	4/. V _{out} >3.8Vdc requires V _{in} >5.0Vdc !							8.1kΩ	21.2kΩ
4.0							5.2kΩ	12.9kΩ	
4.1							3.0kΩ	7.9kΩ	
4.2							1.3kΩ	4.6kΩ	
4.3								2.2kΩ	

R1 = (Blue) R2 = Black

PT6500 Series

Using the Standby Function on the PT6500 5V/3.3V Bus Converters

For applications requiring output voltage On/Off control, the 14-pin PT6500 ISR series incorporates a standby function. This function may be used in applications that require power-up/shutdown sequencing, and wherever there is a requirement for the output status of the module to be controlled by external circuitry.

The standby function is provided by the *STBY** control, pin 3. If pin 3 is left open-circuit the regulator operates normally, and provides a regulated output when a valid supply voltage is applied to V_{in} (pins 4, 5, & 6) with respect to GND (pins 7-10). If a low voltage² is then applied to pin-3 the regulator output will be disabled and the input current drawn by the ISR will drop to less than 50mA⁴. The standby control may also be used to hold-off the regulator output during the period that input power is applied.

The standby control pin is ideally controlled using an open-collector (or open-drain) discrete transistor (See Figure 1). It may also be driven directly from a dedicated TTL³ compatible gate. Table 1 provides details of the threshold requirements.

Table 1 Inhibit Control Thresholds^(2,3)

Parameter	Min	Max
Enable (V_{IH})	1V	5V
Disable (V_{IL})	-0.1V	0.35V

Notes:

1. The Standby/Inhibit control logic is similar for all Power Trends' modules, but the flexibility and threshold tolerances will be different. For specific information on this function for other regulator models, consult the applicable application note.
2. The Standby control pin is ideally controlled using an open-collector (or open-drain) discrete transistor and requires no external pull-up resistor. The control input has an open-circuit voltage of about 1Vdc. To disable the regulator output, the control pin must be pulled to less than 0.35Vdc with a low-level 0.5mA sink to ground.
3. The Standby input on the PT6500 series may be driven by a differential output device, making it compatible with TTL logic. A standard TTL logic gate will meet the 0.35V $V_{IH(max)}$ requirement (Table 1) at 0.5mA I_{OL} . *Do not* use devices that can drive the Standby control input above 5Vdc.
4. When the regulator output is disabled the current drawn from the input source is reduced to approximately 30–40mA (50mA maximum).

Figure 1

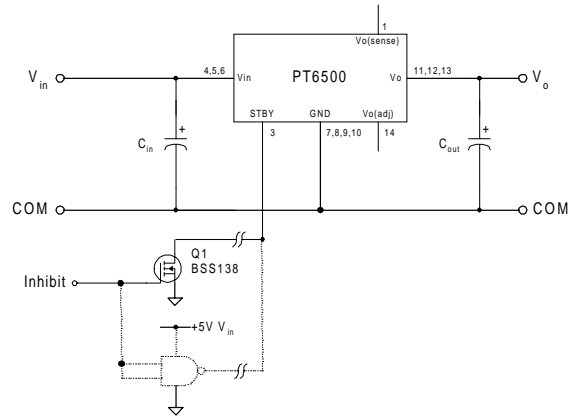

Turn-On Time: In the circuit of Figure 1, turning Q_1 on applies a low voltage to the Standby control (pin 3) and disables the regulator output. Correspondingly, turning Q_1 off releases the low-voltage signal and enables the output. The PT6500 ISR series regulators have a fast response and will provide a fully regulated output voltage within 250 μ sec. The actual turn-on time will vary with load and the total amount of output capacitance. The waveform of Figure 2 shows the typical output voltage response of a PT6501 (3.3V) following the turn-off of Q_1 at time $t = 0.0$ secs. The waveform was measured with a 5Vdc input voltage, and 0.6 Ω load.

Figure 2

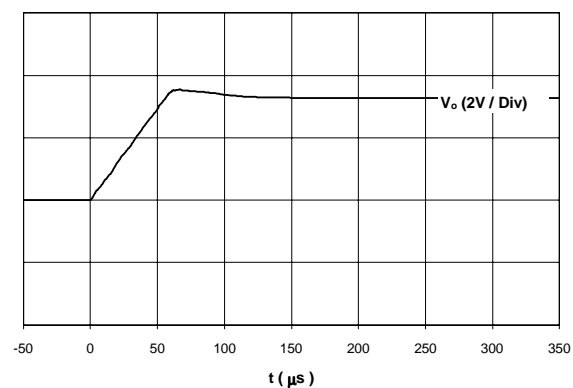

PACKAGING INFORMATION

Orderable Device	Status ⁽¹⁾	Package Type	Package Drawing	Pins	Package Qty	Eco Plan ⁽²⁾	Lead/Ball Finish	MSL Peak Temp ⁽³⁾
PT6501A	NRND	SIP MOD ULE	EEA	14	12	TBD	Call TI	Level-1-215C-UNLIM
PT6501B	NRND	SIP MOD ULE	EEK	14	12	TBD	Call TI	Level-1-215C-UNLIM
PT6501C	NRND	SIP MOD ULE	EEC	14	12	TBD	Call TI	Level-1-215C-UNLIM
PT6501G	NRND	SIP MOD ULE	EEG	14	12	TBD	Call TI	Level-1-215C-UNLIM
PT6501H	NRND	SIP MOD ULE	EEH	14	12	TBD	Call TI	Level-1-215C-UNLIM
PT6501L	NRND	SIP MOD ULE	EEL	14	12	TBD	Call TI	Level-1-215C-UNLIM
PT6501N	NRND	SIP MOD ULE	EED	14	12	TBD	Call TI	Level-1-215C-UNLIM
PT6501R	NRND	SIP MOD ULE	EEE	14	12	TBD	Call TI	Level-1-215C-UNLIM
PT6502A	NRND	SIP MOD ULE	EEA	14	12	TBD	Call TI	Level-1-215C-UNLIM
PT6502B	NRND	SIP MOD ULE	EEK	14	12	TBD	Call TI	Level-1-215C-UNLIM
PT6502G	NRND	SIP MOD ULE	EEG	14	12	TBD	Call TI	Level-1-215C-UNLIM
PT6502N	NRND	SIP MOD ULE	EED	14	12	TBD	Call TI	Level-1-215C-UNLIM
PT6503A	NRND	SIP MOD ULE	EEA	14	12	TBD	Call TI	Level-1-215C-UNLIM
PT6503B	NRND	SIP MOD ULE	EEK	14	12	TBD	Call TI	Level-1-215C-UNLIM
PT6503C	NRND	SIP MOD ULE	EEC	14	12	TBD	Call TI	Level-1-215C-UNLIM
PT6504B	NRND	SIP MOD ULE	EEK	14	12	TBD	Call TI	Level-1-215C-UNLIM
PT6505N	NRND	SIP MOD ULE	EED	14	12	TBD	Call TI	Level-1-215C-UNLIM
PT6506A	NRND	SIP MOD ULE	EEA	14	12	TBD	Call TI	Level-1-215C-UNLIM
PT6506B	NRND	SIP MOD ULE	EEK	14	12	TBD	Call TI	Level-1-215C-UNLIM
PT6506C	NRND	SIP MOD ULE	EEC	14	12	TBD	Call TI	Level-1-215C-UNLIM
PT6506E	OBSOLETE	SIP MOD ULE	EEC	14		TBD	Call TI	Call TI
PT6506F	NRND	SIP MOD ULE	EEF	14	12	TBD	Call TI	Level-1-215C-UNLIM
PT6506LT	NRND	SIP MOD ULE	EEL	14	100	TBD	Call TI	Level-1-235C-UNLIM
PT6506N	NRND	SIP MOD ULE	EED	14	12	TBD	Call TI	Level-1-215C-UNLIM
PT6507A	OBSOLETE	SIP MOD ULE	EEA	14		TBD	Call TI	Call TI

Orderable Device	Status ⁽¹⁾	Package Type	Package Drawing	Pins	Package Qty	Eco Plan ⁽²⁾	Lead/Ball Finish	MSL Peak Temp ⁽³⁾
PT6507B	OBSOLETE	SIP MOD ULE	EEK	14		TBD	Call TI	Call TI
PT6507C	OBSOLETE	SIP MOD ULE	EEC	14		TBD	Call TI	Call TI
PT6507F	OBSOLETE	SIP MOD ULE	EEF	14		TBD	Call TI	Call TI
PT6507G	OBSOLETE	SIP MOD ULE	EEG	14		TBD	Call TI	Call TI
PT6507L	OBSOLETE	SIP MOD ULE	EEL	14		TBD	Call TI	Call TI
PT6507M	OBSOLETE	SIP MOD ULE	EEM	14		TBD	Call TI	Call TI
PT6507N	OBSOLETE	SIP MOD ULE	EED	14		TBD	Call TI	Call TI
PT6507Q	OBSOLETE	SIP MOD ULE	EEQ	14		TBD	Call TI	Call TI
PT6507R	OBSOLETE	SIP MOD ULE	EEE	14		TBD	Call TI	Call TI
PT6508A	OBSOLETE	SIP MOD ULE	EEA	14		TBD	Call TI	Call TI
PT6508B	OBSOLETE	SIP MOD ULE	EEK	14		TBD	Call TI	Call TI
PT6508C	OBSOLETE	SIP MOD ULE	EEC	14		TBD	Call TI	Call TI
PT6508F	OBSOLETE	SIP MOD ULE	EEF	14		TBD	Call TI	Call TI
PT6508G	OBSOLETE	SIP MOD ULE	EEG	14		TBD	Call TI	Call TI
PT6508L	OBSOLETE	SIP MOD ULE	EEL	14		TBD	Call TI	Call TI
PT6508M	OBSOLETE	SIP MOD ULE	EEM	14		TBD	Call TI	Call TI
PT6508N	OBSOLETE	SIP MOD ULE	EED	14		TBD	Call TI	Call TI
PT6508Q	OBSOLETE	SIP MOD ULE	EEQ	14		TBD	Call TI	Call TI
PT6508R	OBSOLETE	SIP MOD ULE	EEE	14		TBD	Call TI	Call TI

⁽¹⁾ The marketing status values are defined as follows:

ACTIVE: Product device recommended for new designs.

LIFEBUY: TI has announced that the device will be discontinued, and a lifetime-buy period is in effect.

NRND: Not recommended for new designs. Device is in production to support existing customers, but TI does not recommend using this part in a new design.

PREVIEW: Device has been announced but is not in production. Samples may or may not be available.

OBSOLETE: TI has discontinued the production of the device.

⁽²⁾ Eco Plan - The planned eco-friendly classification: Pb-Free (RoHS), Pb-Free (RoHS Exempt), or Green (RoHS & no Sb/Br) - please check <http://www.ti.com/productcontent> for the latest availability information and additional product content details.

TBD: The Pb-Free/Green conversion plan has not been defined.

Pb-Free (RoHS): TI's terms "Lead-Free" or "Pb-Free" mean semiconductor products that are compatible with the current RoHS requirements for all 6 substances, including the requirement that lead not exceed 0.1% by weight in homogeneous materials. Where designed to be soldered at high temperatures, TI Pb-Free products are suitable for use in specified lead-free processes.

Pb-Free (RoHS Exempt): This component has a RoHS exemption for either 1) lead-based flip-chip solder bumps used between the die and

package, or 2) lead-based die adhesive used between the die and leadframe. The component is otherwise considered Pb-Free (RoHS compatible) as defined above.

Green (RoHS & no Sb/Br): TI defines "Green" to mean Pb-Free (RoHS compatible), and free of Bromine (Br) and Antimony (Sb) based flame retardants (Br or Sb do not exceed 0.1% by weight in homogeneous material)

⁽³⁾ MSL, Peak Temp. -- The Moisture Sensitivity Level rating according to the JEDEC industry standard classifications, and peak solder temperature.

Important Information and Disclaimer:The information provided on this page represents TI's knowledge and belief as of the date that it is provided. TI bases its knowledge and belief on information provided by third parties, and makes no representation or warranty as to the accuracy of such information. Efforts are underway to better integrate information from third parties. TI has taken and continues to take reasonable steps to provide representative and accurate information but may not have conducted destructive testing or chemical analysis on incoming materials and chemicals. TI and TI suppliers consider certain information to be proprietary, and thus CAS numbers and other limited information may not be available for release.

In no event shall TI's liability arising out of such information exceed the total purchase price of the TI part(s) at issue in this document sold by TI to Customer on an annual basis.

IMPORTANT NOTICE

Texas Instruments Incorporated and its subsidiaries (TI) reserve the right to make corrections, modifications, enhancements, improvements, and other changes to its products and services at any time and to discontinue any product or service without notice. Customers should obtain the latest relevant information before placing orders and should verify that such information is current and complete. All products are sold subject to TI's terms and conditions of sale supplied at the time of order acknowledgment.

TI warrants performance of its hardware products to the specifications applicable at the time of sale in accordance with TI's standard warranty. Testing and other quality control techniques are used to the extent TI deems necessary to support this warranty. Except where mandated by government requirements, testing of all parameters of each product is not necessarily performed.

TI assumes no liability for applications assistance or customer product design. Customers are responsible for their products and applications using TI components. To minimize the risks associated with customer products and applications, customers should provide adequate design and operating safeguards.

TI does not warrant or represent that any license, either express or implied, is granted under any TI patent right, copyright, mask work right, or other TI intellectual property right relating to any combination, machine, or process in which TI products or services are used. Information published by TI regarding third-party products or services does not constitute a license from TI to use such products or services or a warranty or endorsement thereof. Use of such information may require a license from a third party under the patents or other intellectual property of the third party, or a license from TI under the patents or other intellectual property of TI.

Reproduction of TI information in TI data books or data sheets is permissible only if reproduction is without alteration and is accompanied by all associated warranties, conditions, limitations, and notices. Reproduction of this information with alteration is an unfair and deceptive business practice. TI is not responsible or liable for such altered documentation. Information of third parties may be subject to additional restrictions.

Resale of TI products or services with statements different from or beyond the parameters stated by TI for that product or service voids all express and any implied warranties for the associated TI product or service and is an unfair and deceptive business practice. TI is not responsible or liable for any such statements.

TI products are not authorized for use in safety-critical applications (such as life support) where a failure of the TI product would reasonably be expected to cause severe personal injury or death, unless officers of the parties have executed an agreement specifically governing such use. Buyers represent that they have all necessary expertise in the safety and regulatory ramifications of their applications, and acknowledge and agree that they are solely responsible for all legal, regulatory and safety-related requirements concerning their products and any use of TI products in such safety-critical applications, notwithstanding any applications-related information or support that may be provided by TI. Further, Buyers must fully indemnify TI and its representatives against any damages arising out of the use of TI products in such safety-critical applications.

TI products are neither designed nor intended for use in military/aerospace applications or environments unless the TI products are specifically designated by TI as military-grade or "enhanced plastic." Only products designated by TI as military-grade meet military specifications. Buyers acknowledge and agree that any such use of TI products which TI has not designated as military-grade is solely at the Buyer's risk, and that they are solely responsible for compliance with all legal and regulatory requirements in connection with such use.

TI products are neither designed nor intended for use in automotive applications or environments unless the specific TI products are designated by TI as compliant with ISO/TS 16949 requirements. Buyers acknowledge and agree that, if they use any non-designated products in automotive applications, TI will not be responsible for any failure to meet such requirements.

Following are URLs where you can obtain information on other Texas Instruments products and application solutions:

Products

Amplifiers	amplifier.ti.com
Data Converters	dataconverter.ti.com
DSP	dsp.ti.com
Clocks and Timers	www.ti.com/clocks
Interface	interface.ti.com
Logic	logic.ti.com
Power Mgmt	power.ti.com
Microcontrollers	microcontroller.ti.com
RFID	www.ti-rfid.com
RF/IF and ZigBee® Solutions	www.ti.com/lprf

Applications

Audio	www.ti.com/audio
Automotive	www.ti.com/automotive
Broadband	www.ti.com/broadband
Digital Control	www.ti.com/digitalcontrol
Medical	www.ti.com/medical
Military	www.ti.com/military
Optical Networking	www.ti.com/opticalnetwork
Security	www.ti.com/security
Telephony	www.ti.com/telephony
Video & Imaging	www.ti.com/video
Wireless	www.ti.com/wireless

Mailing Address: Texas Instruments, Post Office Box 655303, Dallas, Texas 75265
Copyright © 2008, Texas Instruments Incorporated